



名称：涡轮增压器
型号：TBP4
主机厂号：D38-000-26
应用发动机：上柴

Name: Turbocharger
Model: TBP4
OEM: D38-000-26
Type: Shanghai



名称：涡轮增压器
型号：TBP4
主机厂号：D38-000-181
应用发动机：上柴

Name: Turbocharger
Model: TBP4
OEM: D38-000-181
Type: Shanghai diesel engine

SHIYAN POWER ENGINE INDUSTRIAL AND TRADING CO., LTD.



名称：涡轮增压器
型号：RHE6
应用发动机：上柴

Name: Turbocharger
Model: RHE6
Type: Shanghai diesel engine

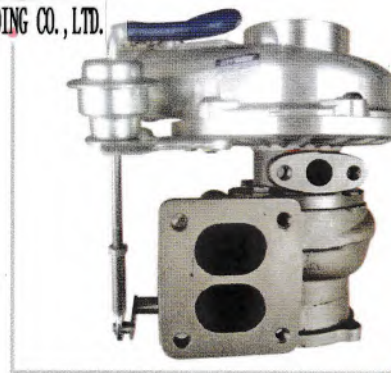

名称：涡轮增压器
型号：RHE6
应用发动机：上柴

Name: Turbocharger
Model: RHE6
Type: Shanghai diesel engine



名称：涡轮增压器
型号：RHE6
主机厂号：Q30-553(Z)-4
应用发动机：上柴

Name: Turbocharger
Model: RHE6
OEM: Q30-553(Z)-4
Type: Shanghai



名称：涡轮增压器
型号：K31
主机厂号：53319706710

Name: Turbocharger
Model: K31
OEM: 53319706710

P 产品介绍 Product introduction



名称：涡轮增压器 Name : Turbocharger
 型号：WH1E Model : WH1E
 主机厂号：1118010-2H_AKZ5A2 OEM : 1118010-2H_AKZ5A2
 应用发动机：锡柴 Type : Stannic bavin



名称：涡轮增压器 Name : Turbocharger
 型号：WH1E Model : WH1E
 主机厂号：1118010H_BKZ OEM : 1118010H_BKZ
 应用发动机：锡柴 Type : Stannic bavin



名称：涡轮增压器 Name : Turbocharger
 型号：HX40W Model : HX40W
 主机厂号：1118010B600-0263 OEM : 1118010B600-0263
 应用发动机：锡柴6DL Type : Stannic bavin 6DL



名称：涡轮增压器 Name: Turbocharger
 型号：HX40W Model : HX40W
 主机厂号：1118010-610-0000J OEM : 1118010-610-0000J
 应用发动机：锡柴 Type : Stannic bavin

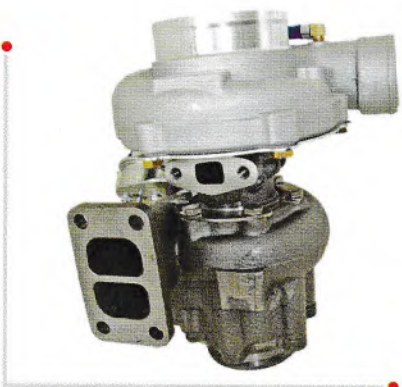

名称：涡轮增压器 Name : Turbocharger
 型号：TBP4 Model : TBP4
 主机厂号：1118010S-BKZ OEM : 1118010S-BKZ
 应用发动机：锡柴 Type : Stannic bavin



名称：涡轮增压器 Name : Turbocharger
 型号：HX55W Model : HX55W
 主机厂号：1118010AM01-074A OEM : 1118010AM01-074A
 应用发动机：锡柴 Type : Stannic bavin

SHIYAN POWER ENGINE INDUSTRIAL AND TRADING CO., LTD.

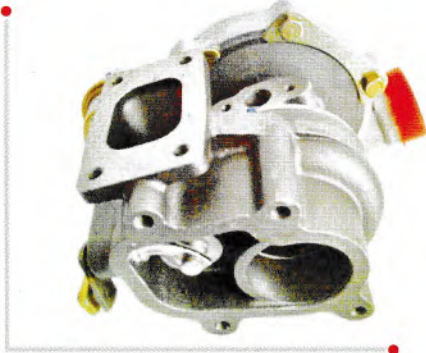

名称：涡轮增压器 Name : Turbocharger
 型号：GT22 Model : GT22
 主机厂号：1118010G5X4 OEM : 1118010G5X4
 应用发动机：大柴498 Type : 大柴498



名称：涡轮增压器 Name : Turbocharger
 型号：TB28 Model : TB28
 主机厂号：1118010-1_4BKZ OEM : 1118010-1_4BKZ
 应用发动机：锡柴 Type : Stannic bavin



名称：涡轮增压器 Name : Turbocharger
 型号：TB28 Model : TB28
 主机厂号：1118010A-1_4AKZ1 OEM : 1118010A-1_4AKZ1
 应用发动机：锡柴 Type : Stannic bavin

SHIYAN POWER ENGINE INDUSTRIAL AND TRADING CO., LTD.



名称：涡轮增压器 Name : Turbocharger
 型号：GT25 Model : GT25
 主机厂号：1118010-543-JH30T OEM : 1118010-543-JH30T
 应用发动机：锡柴 Type : Stannic bavin



名称：涡轮增压器 Name:Turbocharger
 型号：TBP4 Model : TBP4
 主机厂号：1118010H_AKZ OEM : 1118010H_AKZ
 应用发动机：锡柴 Type : Stannic bavin



名称：涡轮增压器 Name:Turbocharger
 型号：TBP4 Model : TBP4
 主机厂号：1118010S-6DF1 OEM : 1118010S-6DF1
 应用发动机：锡柴 Type : Stannic bavin

P 产品介绍 **Product introduction**



名称：涡轮增压器 Name : Turbocharger
 型号：RHB5 Model : RHB5
 主机厂号：897160801 OEM : 897160801
 应用发动机：4JB1 Type : 4JB1

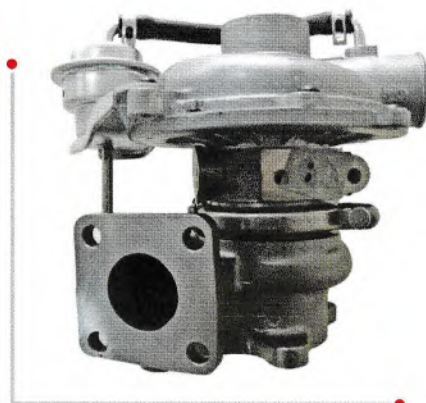

名称：涡轮增压器 Name : Turbocharger
 型号：RHF4 Model : RHF4
 主机厂号：1118010-44 OEM : 1118010-44
 应用发动机：4JB1-TCT Type : 4JB1-TCT

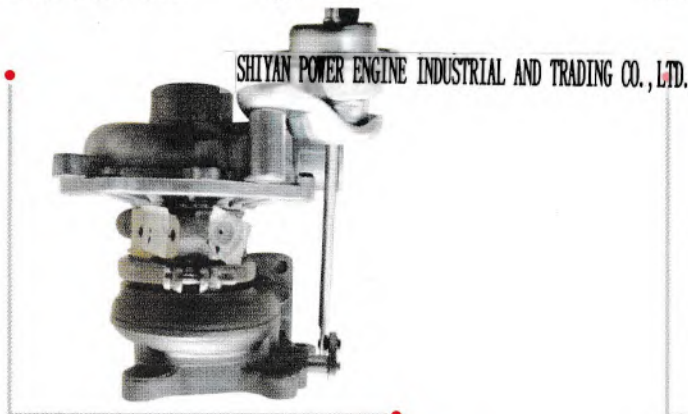

名称：涡轮增压器 Name : Turbocharger
 型号：RHF4 Model : RHF4
 主机厂号：1118010-802 OEM : 1118010-802
 应用发动机：4JB1-TC Type : 4JB1-TC

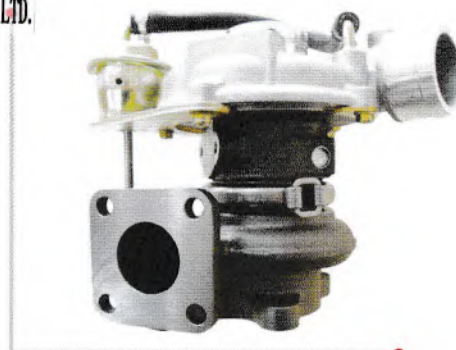

名称：涡轮增压器 Name : Turbocharger
 型号：RHF4 Model : RHF4
 主机厂号：XNZ11186000 OEM : XNZ11186000
 应用发动机：4JB1 Type : 4JB1



名称：涡轮增压器 Name : Turbocharger
 型号：RHF4 Model : RHF4
 主机厂号：97300197 OEM : 97300197
 应用发动机：索菲姆8140.23 Type : 索菲姆8140.23

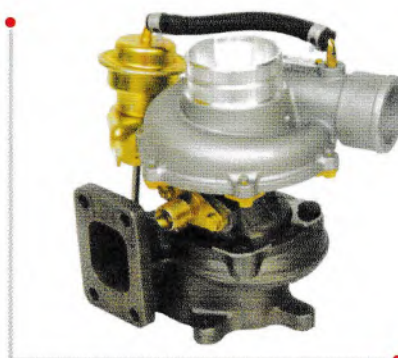

名称：涡轮增压器 Name : Turbocharger
 型号：RHB5 Model : RHB5
 主机厂号：97210034 OEM : 97210034
 应用发动机：索菲姆8140.47 Type : Sofim 8140.47



名称：涡轮增压器 Name : Turbocharger
 型号：TB25 Model : TB25
 主机厂号：1118300TC OEM : 1118300TC
 应用发动机：江铃 Type : JMC

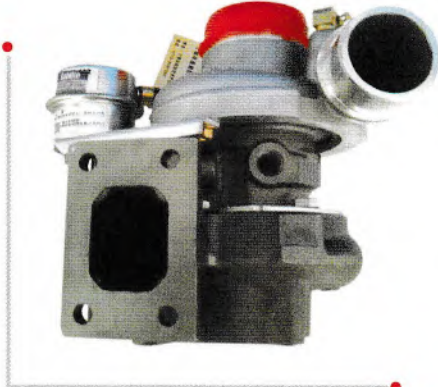

名称：涡轮增压器 Name : Turbocharger
 型号：TB25 Model : TB25
 主机厂号：1118300ADB1 OEM : 1118300ADB1
 应用发动机：江铃 Type : JMC



名称：涡轮增压器 Name : Turbocharger
 型号：SJ60F Model : SJ60F
 主机厂号：10980219 OEM : 10980219
 应用发动机：485 Type : 485



名称：涡轮增压器 Name : Turbocharger
 型号：RHF4 Model : RHF4
 主机厂号：1118300RAA OEM : 1118300RAA
 应用发动机：R425DOHC Type : R425DOHC

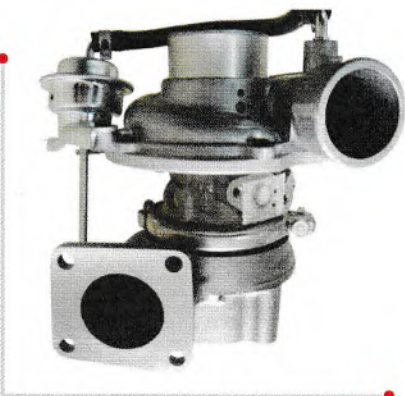

名称：涡轮增压器 Name : Turbocharger
 型号：RHF5 Model : RHF5
 主机厂号：1118010-850 OEM : 1118010-850
 应用发动机：4KH1-TC Type : 4KH1-TC



名称：涡轮增压器 Name : Turbocharger
 型号：RHF4 Model : RHF4
 主机厂号：1118010-PA01 OEM : 1118010-PA01
 应用发动机：4JB1-TC1 Type : 4JB1-TC1

SHIYAN POWER ENGINE INDUSTRIAL AND TRADING CO., LTD.

P

产品介绍

Product introduction

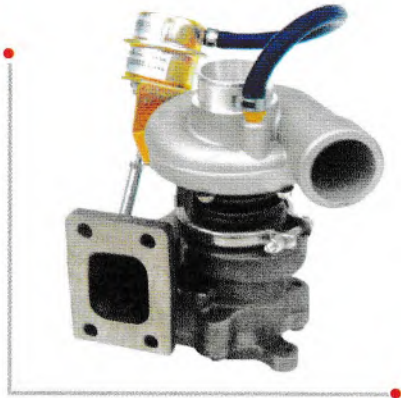

名称：涡轮增压器
型号：JP4

Name : Turbocharger
Model : JP4



名称：涡轮增压器
型号：TF035

Name : Turbocharger
Model : TF035



名称：涡轮增压器
型号：QD32

Name : Turbocharger
Model : QD32

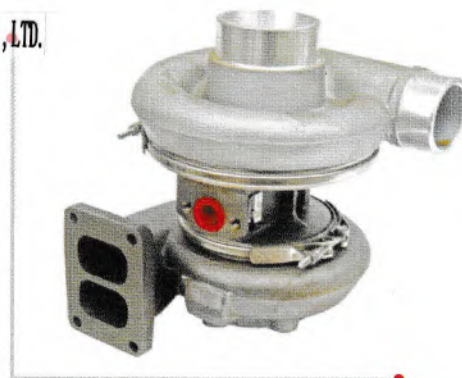

名称：涡轮增压器
型号：4LGK
应用发动机：奔驰

Name : Turbocharger
Model : 4LGK
Type : Benz



名称：涡轮增压器
型号：110J-2

Name : Turbocharger
Model : 110J-2

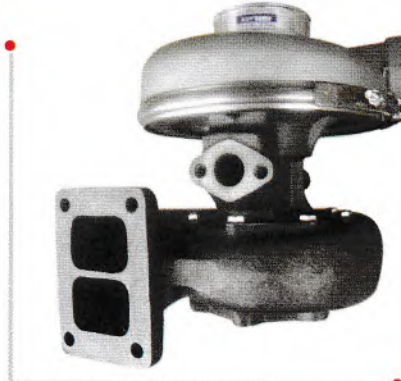

名称：涡轮增压器
型号：GJ110

Name : Turbocharger
Model : GJ110

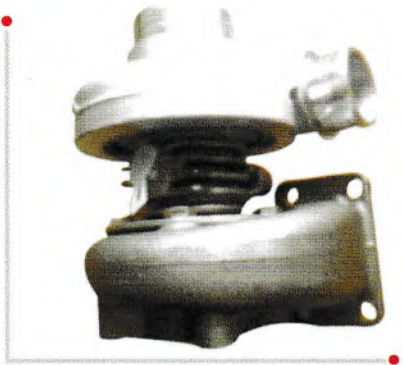

名称：涡轮增压器 Name : Turbocharger
 型号：GT22 Model : GT22
 应用发动机：福田483 Type : Foton 483

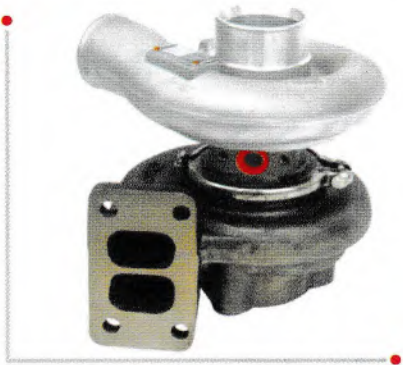

名称：涡轮增压器 Name : Turbocharger
 型号：CAT 320 Model : CAT 320
 应用发动机：卡特320 Type : CAT 320

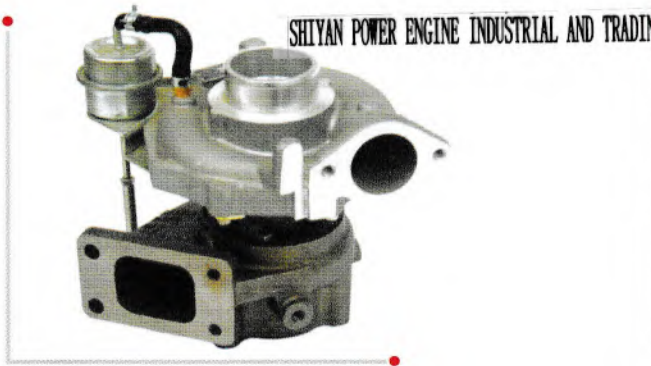

名称：涡轮增压器 Name : Turbocharger
 型号：SK250-8 Model : SK250-8
 应用发动机：神缸 Type : Shen gang



名称：涡轮增压器 Name : Turbocharger
 型号：EX200-2 Model : EX200-2



名称：涡轮增压器 Name : Turbocharger
 型号：TD07 Model : TD07

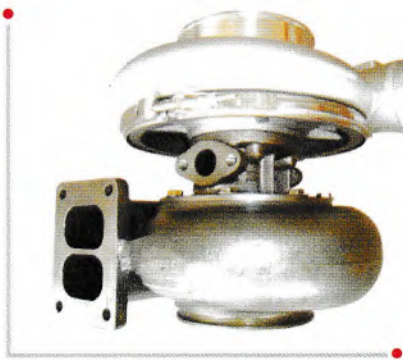

名称：涡轮增压器 Name : Turbocharger
 型号：HC5A Model : HC5A
 主机厂号：3523850 OEM : 3523850

P 产品介绍 **Product introduction**



名称：涡轮增压器 Name : Turbocharger
主机厂号：07122012922 OEM : 07122012922

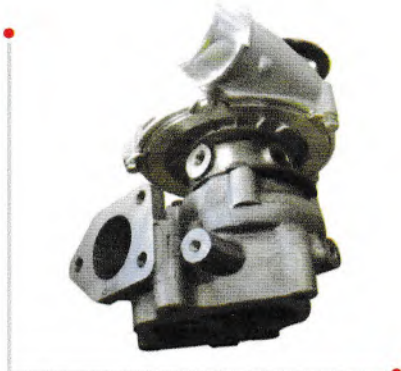

名称：涡轮增压器 Name : Turbocharger
型号：GT17 Model : GT17
主机厂号：28200 4A001 OEM : 28200 4A001

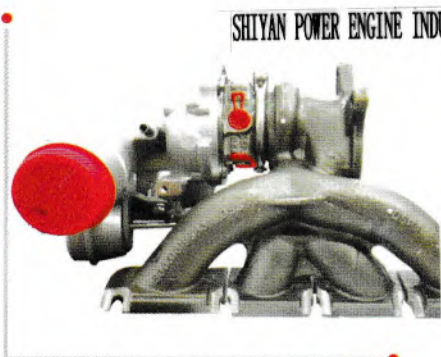

名称：涡轮增压器 Name : Turbocharger
主机厂号：07122012926 OEM : 07122012926

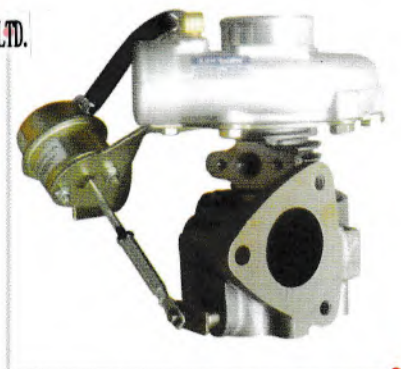

名称：涡轮增压器 Name : Turbocharger
型号：GT22 Model : GT22
主机厂号：1118300SD OEM : 1118300SD
应用发动机：江铃 Type : JMC



名称：涡轮增压器 Name : Turbocharger
型号：GT22 Model : GT22
主机厂号：1118300SZ OEM : 1118300SZ
应用发动机：江铃 Type : JMC



名称：涡轮增压器 Name : Turbocharger
型号：GT22 Model : GT22
主机厂号：1118300DL OEM : 1118300DL
应用发动机：江铃 Type : JMC

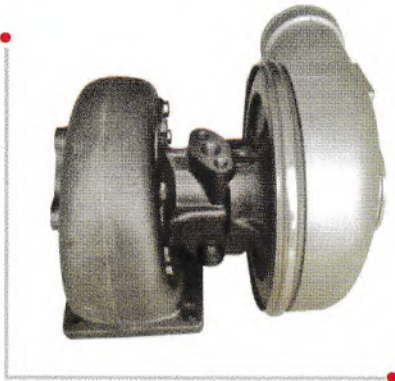

名称：涡轮增压器
型号：GJ112

Name : Turbocharger
Model : GJ112

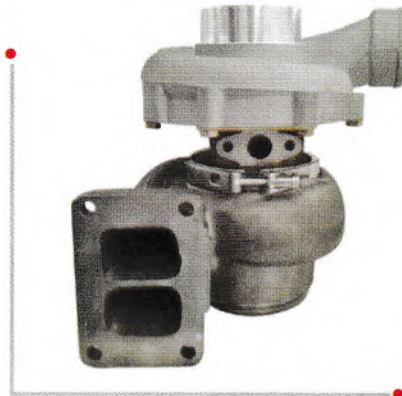

名称：涡轮增压器
型号：PC400

Name : Turbocharger
Model : PC400

SHIYAN POWER ENGINE INDUSTRIAL AND TRADING CO., LTD.



名称：涡轮增压器
主机厂号：49188-01831

Name : Turbocharger
OEM : 49188-01831



名称：涡轮增压器

Name : Turbocharger



名称：涡轮增压器
主机厂号：TD04 4D56T

Name : Turbocharger
OEM : TD04 4D56T



名称：涡轮增压器
主机厂号：1118100-ED01A

Name : Turbocharger
OEM : 1118100-ED01A

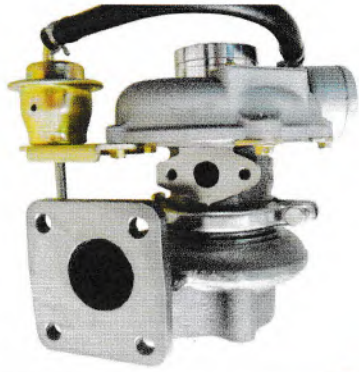

名称：涡轮增压器 Name : Turbocharger
 型号：RHF4 Model : RHF4
 主机厂号：97300198 OEM : 97300198
 应用发动机：SOFIM8140.43 Type : SOFIM8140.43



名称：涡轮增压器 Name : Turbocharger
 型号：RHB5 Model : RHB5
 主机厂号：97210008 OEM : 97210008
 应用发动机：SOFIM8140.27 Type : Sofim8140.27



名称：涡轮增压器 Name : Turbocharger
 型号：RHF4 Model : RHF4
 主机厂号：97300952 OEM : 97300952
 应用发动机：SOFIM8140.43S Type : SOFIM8140.43S



名称：涡轮增压器机芯 Name : Turbocharger movement
 型号：HX 40 Model : HX 40

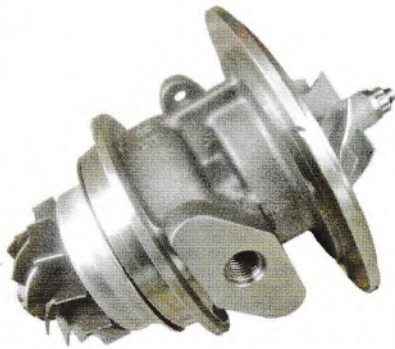

名称：涡轮增压器机芯 Name : Turbocharger movement
 型号：HX30 Model : HX30

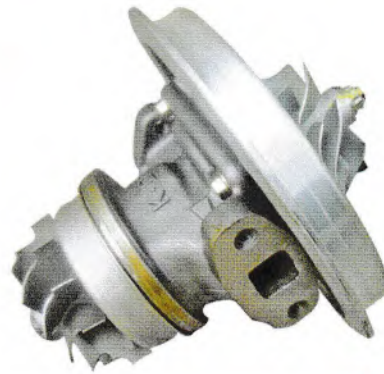

名称：涡轮增压器机芯 Name : Turbocharger movement
 型号：WH1C Model : WH1C

SHIYAN POWER ENGINE INDUSTRIAL AND TRADING CO., LTD.

P 产品介绍 Product introduction



名称：中间壳
型号：TB34

Name : bearing housing
Model : TB34

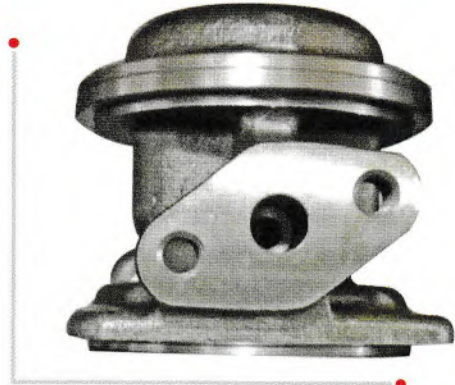

名称：中间壳
型号：H1C

Name : bearing housing
Model : H1C

SHIYAN POWER ENGINE INDUSTRIAL AND TRADING CO., LTD.



名称：中间壳
型号：TB28

Name : bearing housing
Model : TB28



名称：中间壳
型号：HX40

Name : bearing housing
Model : HX40



名称：中间壳
型号：HX50

Name : bearing housing
Model : HX50



名称：中间壳
型号：K03

Name : bearing housing
Model : K03

P 产品介绍 Product introduction



名称：涡轮壳
型号：HX35

Name : Turbine casing
Model : HX35



名称：涡轮壳
型号：HX30

Name : Turbine casing
Model : HX30

SHIYAN POWER ENGINE INDUSTRIAL AND TRADING CO., LTD.

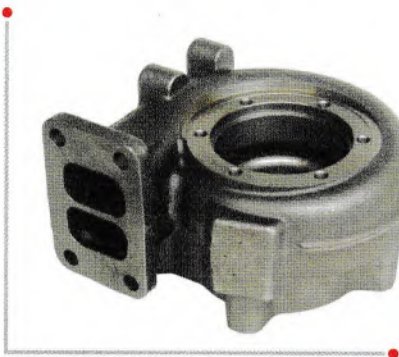

名称：涡轮壳
型号：HX40

Name : Turbine casing
Model : HX40



名称：涡轮壳
型号：HX40

Name : Turbine casing
Model : HX40

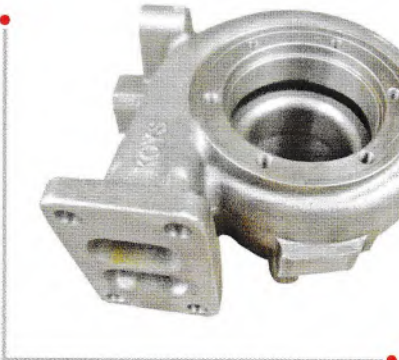

名称：涡轮壳
型号：HX40

Name : Turbine casing
Model : HX40

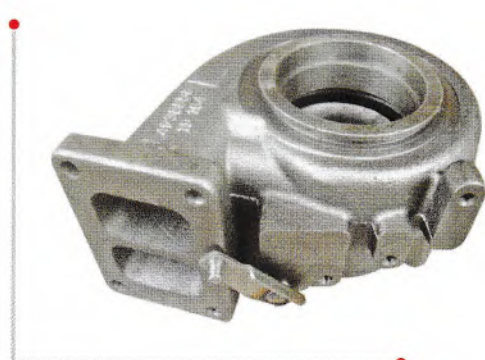

名称：涡轮壳
型号：HX55

Name : Turbine casing
Model : HX55

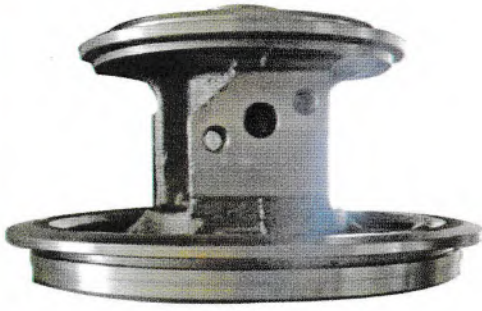
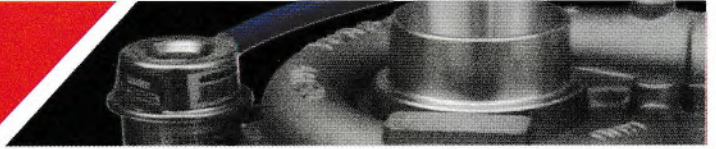

名称：中间壳
型号：K29

Name : bearing housing
Model : K29



名称：中间壳
型号：TB28水冷

Name : bearing housing
Model : TB28 water-cooling

SHIYAN POWER ENGINE INDUSTRIAL AND TRADING CO., LTD.

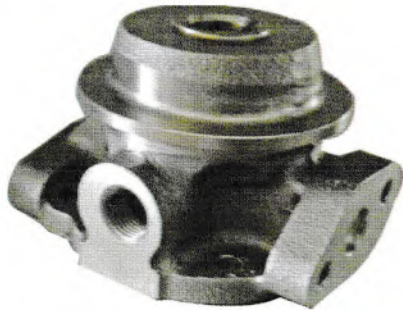

名称：中间壳
型号：TB34水冷

Name : bearing housing
Model : TB34 water-cooling

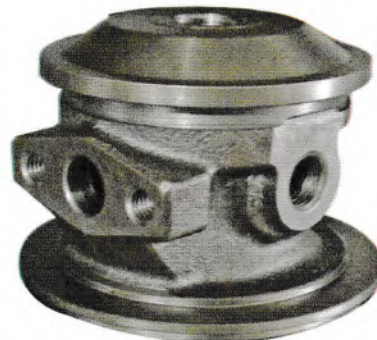

名称：中间壳
型号：GT35水冷

Name : bearing housing
Model : GT35 water-cooling



名称：中间壳
型号：GT17VNP

Name : bearing housing
Model : GT17VNP

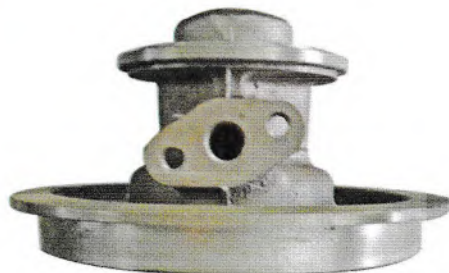

名称：中间壳
型号：HX55

Name : bearing housing
Model : HX55



名称：压壳
型号：HX40

Name : Pressure shell
Model : HX40



名称：压壳
型号：HX30

Name : Pressure shell
Model : HX30

SHIYAN POWER ENGINE INDUSTRIAL AND TRADING CO., LTD.

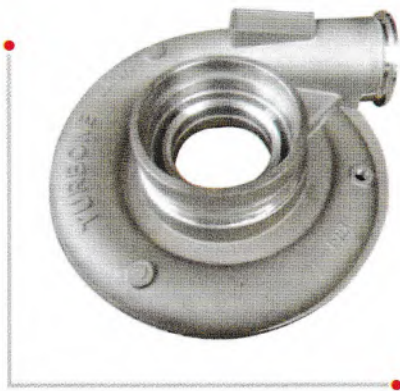

名称：压壳
型号：HX55

Name : Pressure shell
Model : HX55



名称：压壳
型号：HX40

Name : Pressure shell
Model : HX40



名称：扩压板

Name : Diffusion plate



名称：扩压板

Name : Diffusion plate

P 产品介绍 **Product introduction**

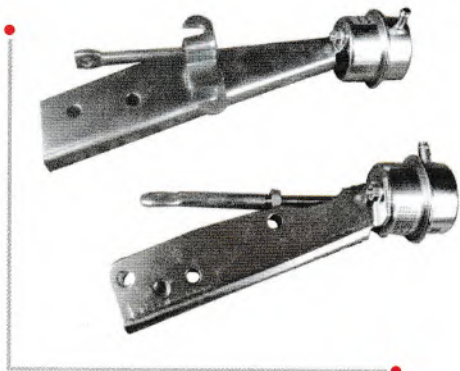

名称：旁通阀

Name : bypass-valve

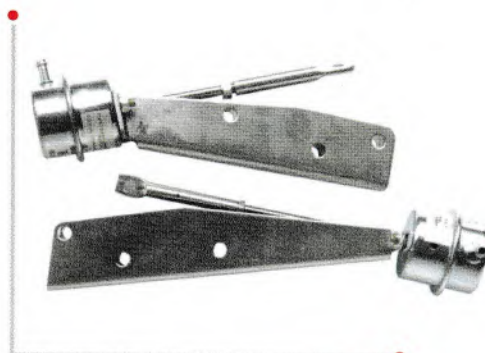

名称：旁通伐

Name : Bypass valve

SHIYAN POWER ENGINE INDUSTRIAL AND TRADING CO., LTD.



名称：旁通伐

Name : Bypass valve



名称：旁通伐

Name : Bypass valve

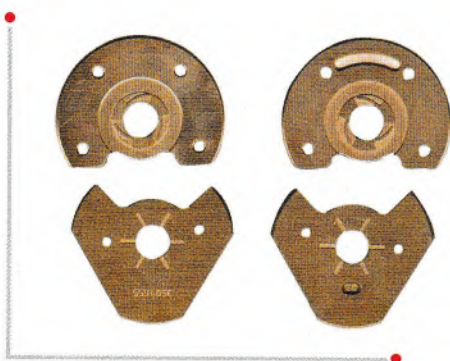

名称：止推轴承

Name : antithrust bearing

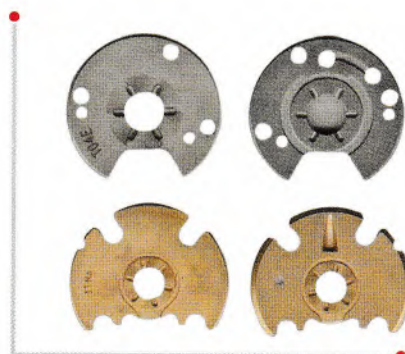

名称：止推轴承

Name : antithrust bearing

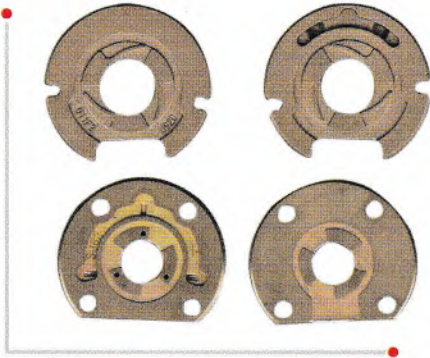

名称：止推轴承 Name : antithrust bearing

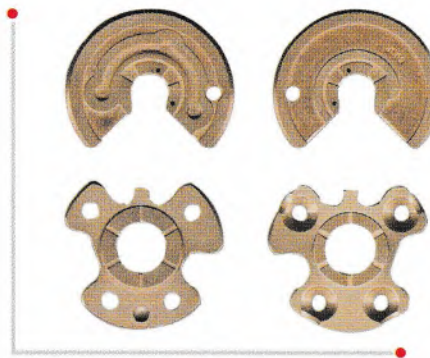

名称：止推轴承 Name : antithrust bearing

SHIYAN POWER ENGINE INDUSTRIAL AND TRADING CO., LTD.



名称：止推轴承 Name : antithrust bearing



名称：止推轴承 Name : antithrust bearing



名称：修理包 Name : maintenance kit



名称：修理包 Name : maintenance kit